



***PMX1000 & PMX1250
RCD Resistor Replacement
Field Service Bulletin***

804950 – Revision 2 – July, 2017

Hypertherm®

Hypertherm Inc.
*Etna Road, P.O. Box 5010
Hanover, NH 03755 USA
603-643-3441 Tel 603-643-5352 Fax
www.hypertherm.com*

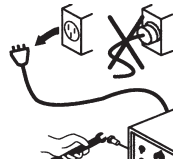
		WARNING ELECTRIC SHOCK CAN KILL
		Disconnect electrical power before performing any maintenance. All work requiring removal of the power supply cover must be performed by a qualified technician. See <i>Section 1</i> of the Operator Manual for more safety precautions.

Introduction

Purpose

Describes necessary steps to replace the RCD resistors (R119 and R120) on the power board of the PMX1000 and PMX1250.

Note: This upgrade only applies to power supplies with serial numbers prior to:

PMX1000 – 1000-013717

PMX1250 – 1250-007888

Tools Needed

Phillips head screwdriver



Wire cutters

Kit Contents

Item	Part Number	Description	Qty
1	109529	24K 13W resistor	2

Replace damaged resistors

1. Disconnect power and remove cover from power supply.
2. Discharge capacitors C94 and C98. See photo below.

		WARNING ELECTRIC SHOCK CAN KILL
Use a multi-meter in VDC mode to discharge the capacitors to less than 10VDC before removing the mounting screws.		

3. Use wire cutters to remove resistors R119 and R120.
Note: cut leads next to the surface of the power board.

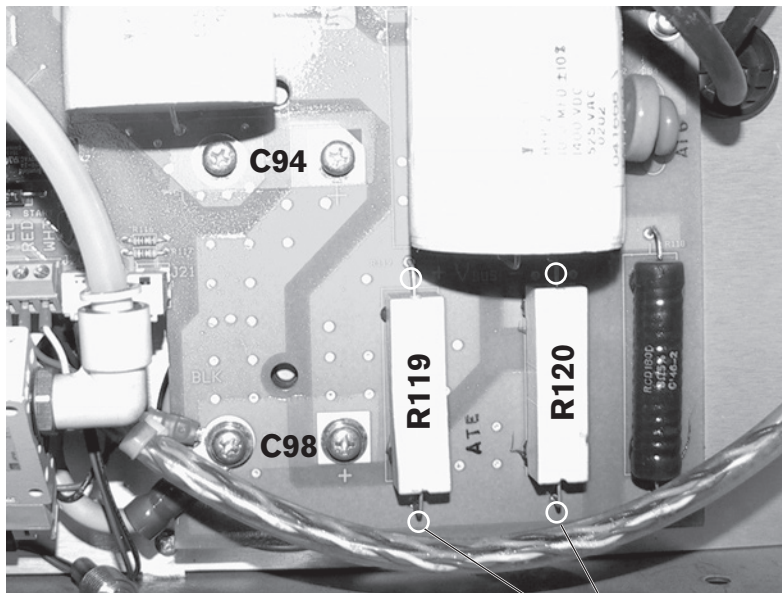

Cut 4 places as shown

4. Remove screws from capacitors C94 and C98 as show.

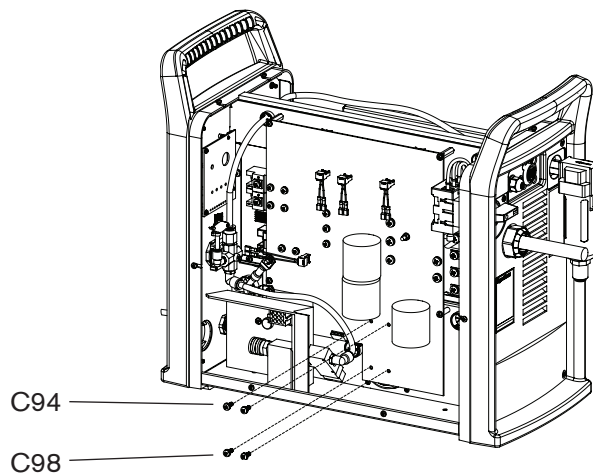

- Install new resistors on capacitors C94 and C98 as shown. Tighten screws to 20 inch pounds (24 kg cm).
 Note: Align bleeder hole on capacitor with view hole on power board.

CAUTION: Cross-threading the screws may cause the capacitors to fail.

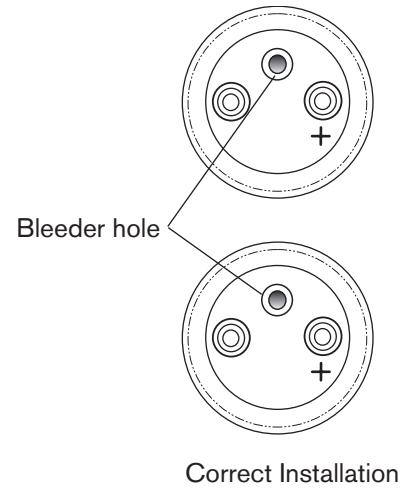
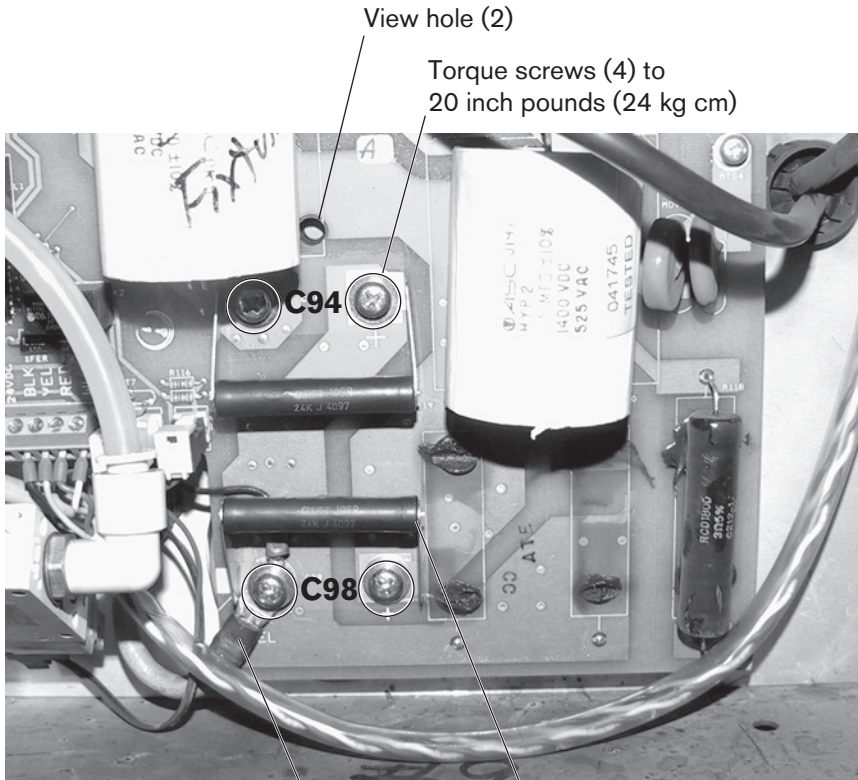

Note: assemble in the following order.
 PCB, resistor, large terminal, small terminal, screw

- Install power supply cover.

© Copyright 2017 Hypertherm Inc.
 All Rights Reserved

Hypertherm and Powermax are trademarks of Hypertherm Inc.
 and may be registered in the United States and/or other countries.