

▼

# MBATX-845GV-VEAH

## User's Guide

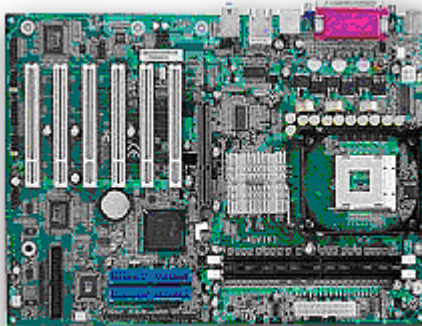

PN: MBATX-845GV-VEAH  
May 2005

## **Customer Service**

**Mailing Address:** Kontron - United States  
14118 Stowe Drive  
Poway, CA 92064 USA  
Tel: 858-677-0877  
Fax: 858-677-0895

**Technical Support:** U.S. and Canadian Customers - 24 hours a day  
Tel: 800-480-0044, option 1  
Fax: 858-677-0898

International Customers - 9am to 4pm local time  
Tel: (+49) 8165-77 112  
Fax: (+49) 8165-77 110

**Visit our site at:** [www.kontron.com](http://www.kontron.com)

**© 2005 Kontron, an International Corporation. All rights reserved.**

The information in this user's guide is provided for *reference* only. Kontron does not assume any liability arising out of the application or use of the information or products described herein. This user's guide may contain or reference information and products protected by copyrights or patents and does not convey any license under the patent rights of Kontron, nor the rights of others.

**Kontron** is a registered trademark of Kontron. All trademarks, registered trademarks, and trade names used in this user's guide are the property of their respective owners. All rights reserved. Printed in the United States of America and Canada. This user's guide contains information proprietary to Kontron. Customers may reprint and use this user's guide in other publications. Customers may alter this user's guide and publish it only after they remove the Kontron name, cover, and logo.

Kontron reserves the right to make changes without notice in product or component design as warranted by evolution in user needs or progress in engineering or manufacturing technology. Changes which affect the operation of the unit will be documented in the next revision of this user's guide.

# CONTENTS

<b>SECTION 1</b>	<b>INTRODUCTION</b>	<b>1</b>
1.1	Unpacking MBATX-845GV-VEAH Series	1
1.2	Description	3
1.3	Features	3
1.3.1	Graphic & Ethernet	3
1.3.2	Ultra ATA/66/100	4
1.3.3	Hardware Monitoring	4
1.3.4	I/O Shield Connector	4
1.3.5	Power-On/Off	5
1.3.6	MBATX-845GV-VEAH Series Overview	5
1.3.7	System Block Diagram	6
1.4	Specifications	7
<b>SECTION 2</b>	<b>INSTALLATIONS</b>	<b>9</b>
2.1	System Installation	9
2.1.1	CPU Installation	9
2.1.2	Heat Sink Installation	10
2.1.3	Memory Module Installation	11
2.1.4	Setting Jumper and DIP Switches	13
2.2	Board Layout	14
2.3	Jumper Setting	15
2.4	Connector's Description	18

# CONTENTS

<b>SECTION 3</b>	<b>AWARD BIOS SETUP</b>	<b>36</b>
3.1	BIOS Instructions	36
3.2	Main Menu	37
3.3	Standard CMOS Features	39
3.4	IDE Adapters	41
3.5	Advanced BIOS Features	43
3.6	Advanced Chipset Features	47
3.7	Integrated Peripherals	50
3.8	Power Management Setup	55
3.9	PnP/PCI Configurations	59
3.10	PC Health Status	60
3.11	Frequency/Voltage Control	62
3.12	Load Fail-Safe Default	64
3.13	Load Optimized Defaults	64
3.14	Supervisor/User Password Setting	65
3.15	Exit Selecting	66

# SECTION 1

## INTRODUCTION

### 1.1 Unpacking MBATX-845GV-VEAH Series

1. Remove the MBATX-845GV-VEAH from the carton and check if the unit is properly sealed in the plastic bag.
2. The carton should contain:



Industrial Board

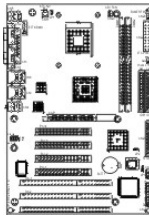

Floppy ribbon cable



ATA-66/100 HDD ribbon cable



Driver Utility



COM2 ribbon cable (1 Set)  
(for RS-232)

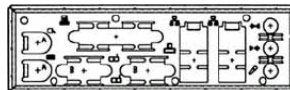

Introduction

- ◆ COM3 ribbon cable (1 Set)  
(for RS-232/422/485)



- ◆ I/O Shield

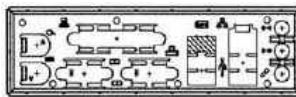

3. Optional Cable

- ◆ USB2.0 cable (optional)

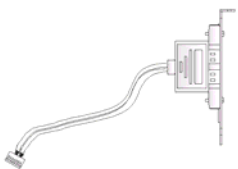

- ◆ COM4 ribbon cable (optional)  
(for RS-232/422/485)



## 1.2 Description

The MBATX-845GV-VEAH series combines the high performance and exceptional value of the Intel® 845GV chipset with a full-featured industrial board. The Intel® advanced 845GV chipset supports regular socket 478-pins Intel® Pentium® 4 / Celeron® processors (1.3GHz up to 3.06GHz). User can set the jumper to select the mobile CPU since the memory base on the FSB 400/533MHz operation supports DDR SDRAM interface. Additionally, the 845GV chipset integrates the VGA function and external graphics device on AGP (845GV support ADD card only). The memory size of MBATX-845GV-VEAH can be up to 2GB DDR including the onboard Intel® 82562ET Ethernet controller (support 10/100 Base-TX Ethernet), Audio and with 4 COM ports. You may also add one slim floppy connector for special applications.

The 82801DB I/O Controller Hub (ICH4) employs the Intel® Accelerated Hub Architecture to make a direct connection from the graphics and memory to the integrated Ethernet controller, the IDE controllers (ATA/33 or ATA/66 or ATA/100), six USB ports that are supported USB 1.1/2.0 standard meets the performance, stability and reliability requirements.

The industrial board - MBATX-845GV-VEAH is suitable for all industry applications and supports Windows® 98/SE/ME/2000 and Windows® XP operation systems.

## 1.3 Features

### 1.3.1 Graphic & Ethernet

The MBATX-845GV-VEAH is based on the Intel® 845GV chipset, offering users full integration of graphic, Ethernet, and audio functions. The features of the chipset include:

- ◆ Enhanced integrated graphics & system performance:
  - 400/533 FSB support
- ◆ Memory:
  - SDRAM PC133, DDR 266/333
  - 2.0GB Max. Memory
  - 2 DIMM, Non-ECC

- ◆ IO Connectivity - ICH4:
  - 6 Hi-Speed USB2.0 ports
  - 10/100 Base-TX Ethernet

### 1.3.2 Ultra ATA/66/100

The ICH4 provides two channel Ultra ATA/66/100 Bus Master IDE controller, that support Ultra ATA/66/100 protocols, perfect for such demanding applications as real-time video, multimedia, and high performance operating system. A new IDE cable is required for Ultra ATA/66/100. This cable is an 80-conductor cable; however the connectors are, of course, backwards compatible with ATA/33.

### 1.3.3 Hardware Monitoring

Hardware monitoring allows you to monitor various aspects of your systems operations and status. The features include CPU temperature, voltage and RPM of fan.

### 1.3.4 I/O Shield Connector

The board is equipped with an I/O back panel. Please use the appropriate I/O shield (figure 1).

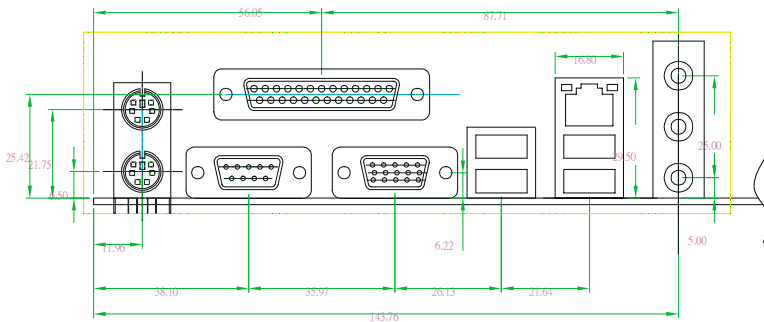

Figure 1: I/O back panel layout



### 1.3.5 Power-On/Off (Remote)

The board has a single 20-pins connector for ATX power supplies. For ATX power supplies that support the Remote On/Off feature, this should be connected to the systems front panel for system Power On/Off button. The systems power On/Off button should be a momentary button that is normally open.

The board has been designed with "Soft Off" functions. You can turn Off the system from one of two sources: The first is the front panel Power On/Off the button, and the other is the "Soft Off" function (coming from the M/B□ onboard circuit controller) that can be controlled by the operating system such as Windows® 98/SE/ME/2000 or Windows® XP.

### 1.3.6 MBATX-845GV-VEAH Series Overview

Function / Model	MBATX-845GV-VEAH
◆ Chipset	Intel® 845GV
◆ LCD Function	/
◆ VGA Function	⊙
◆ SCSI Function	/
◆ Ethernet Function	⊙
◆ Audio Function	⊙
◆ Two EIDE Interface	⊙
◆ One Floppy Interface	⊙
◆ One Parallel	⊙
◆ PCI Slots	6
◆ AGP Slot	1 (For ADD card only)
◆ Serial Port	4
◆ USB 2.0 Port	6 (Two for Optional USB Cable)
◆ Fan Connector	4
◆ Slim Floppy Connector	⊙

### 1.3.7 System Block Diagram

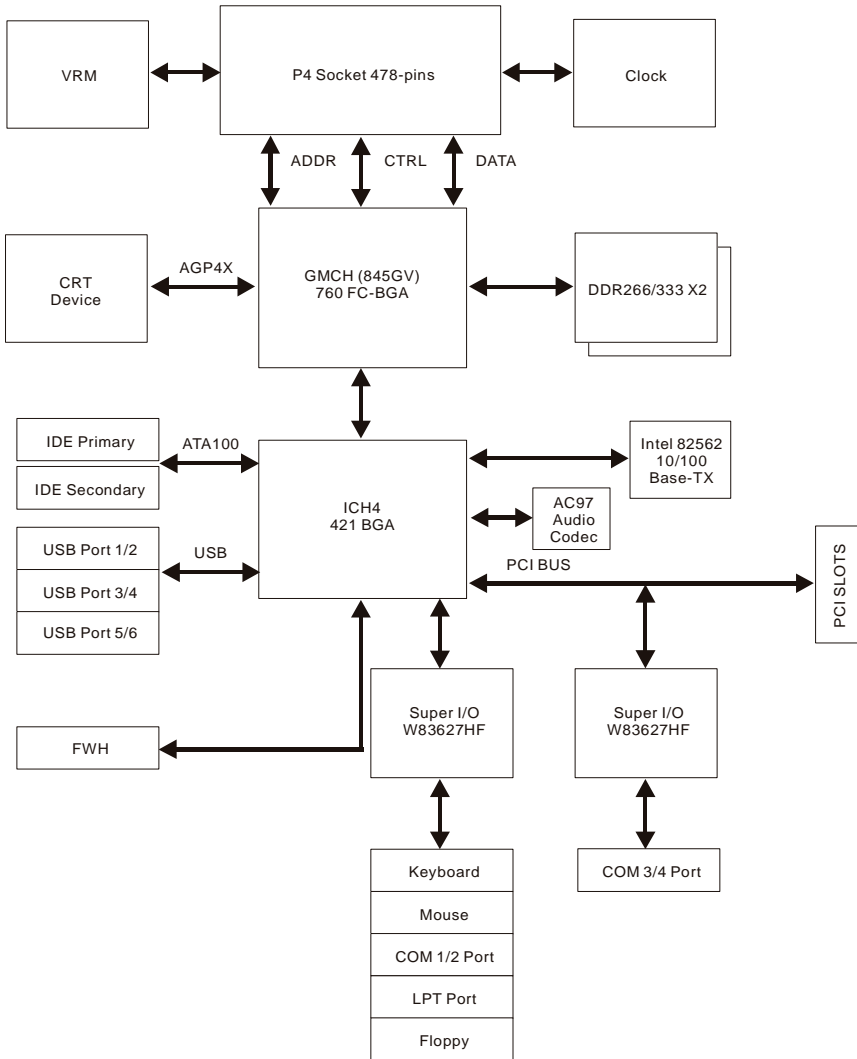

Figure 2: System Block Diagram

## 1.4 Specifications

### ◆ Processor:

- Intel® Pentium® 4/Celeron™ processor with socket 478-pins package, Processor operating at 1.3GHz and up to 3.06GHz
- Intel® Pentium® 4 Mobile™ processor with socket 478-pins package, Processor operating at 1.2GHz and up to 2.4GHz
- System bus frequency at 400/533 MHz FSB

### ◆ Chipset:

- Intel® 82845GV + ICH4 AGPset

### ◆ DRAM Module:

- Two 184-pins Socket
- For DDR 266/333 SDRAM memory
- Support DDR SDRAM up to 2GB (Max.)

### ◆ VGA Function:

- Intel® 845GV Chipset integrated graphic controller
- Onboard one 15-pins VGA connector

### ◆ LAN Function:

- Intel® 82562ET Ethernet controller
- For 10/100Base-TX Ethernet
- Onboard one RJ-45 Ethernet connector
- 

### ◆ Audio Function:

- AC97 audio controller

### ◆ External Connector:

- One slim floppy connector

### ◆ Expansion Slot:

- 1 x AGP slot (for ADD card only)
- 6 x PCI slots

### ◆ Onboard I/O:

- On-Chip I/O integrated with K/B, Mouse, FDD, Parallel and Serial, Fast IR and Power-ON controllers

◆ **Onboard PCI / IDE:**

- Intel® 82801DB (ICH4) controller
- PCI rev2.2 Compliant
- ACPI Compliant Power Management
- PCI bus IDE port with PIO /Ultra DMA-100 x 2 (up to 4 devices)

◆ **Rear I/O Connectors:**

- PS/2 mouse and PS/2 style keyboard
- D-Sub 25-pins printer port connector
- D-Sub 9-pins COM1 serial port connector for RS-232
- D-Sub 15-pins VGA connector
- 2 x USB2.0 connectors
- RJ-45 Ethernet and 2 x USB2.0 connectors
- Audio for Line-In, Line-Out, MIC phone jack

◆ **Internal I/O Connectors (pin-header):**

- 3 x serial ports, COM2 for RS-232 and COM3/4 for RS-232/422/485 (serial cable with bracket by optional)
- 2 x USB2.0 connectors (USB cable with bracket by optional)

◆ **BIOS:**

- Award Plug & Play BIOS

◆ **Form Factor:**

- 12" x 8.7" (305 x 220mm) ATX Size

◆ **Weight:**

- 1.44lb (650g)

## SECTION 2

### INSTALLATIONS

#### 2.1 System Installation

##### 2.1.1 CPU Installation

Carefully follow the steps below in order to install the CPU:

1. Check and confirm that the jumpers are correctly set for the CPU you are going to install (figure 3).
2. Lift the releasing lever of the Socket 478.
3. Align the pin of the CPU against the pinholes of the Socket 478. Be sure to pay attention to the orientation of the CPU.

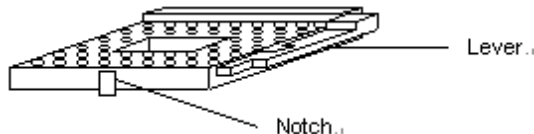

Figure 3: CPU Socket

4. Push down the CPU into the Socket 478.
5. Push down the release lever and lock it against the key hook.
6. Hook the hole in ZIF clip for the CPU cooling fan onto the notch on the socket 478.
7. Place the CPU cooling fan atop the CPU surface.
8. Push down the opposite side of the ZIF clip and hook it.
9. Slide the head of the clip to left and lock it.
10. Connect the cooling fan cable to the socket as shown below. Be careful not to place the cable on the CPU cooling fan.

### Removing a CPU:

1. Before removing the CPU, turn off the MBATX-845GV-VEAH Series power; then wait for about 20 minutes until the heat radiation plate of the cooling fan and the CPU cools down.
2. To remove the CPU, lift the releasing lever of the Socket 478.

Note: The CPU and the heat radiation plate are hot. They may cause burns.

**To remove the CPU, reverse the installation steps.**

#### 2.1.2 Heat Sink & Retention Module Installation

Make sure a secure contact is made between the processors and the heat sinks & fan. Insufficient contact, incorrect types of heat sinks, fans, or thermal compounds, or improper amounts of thermal compound applied on the CPU can cause the processors to overheat, which may crash the system.

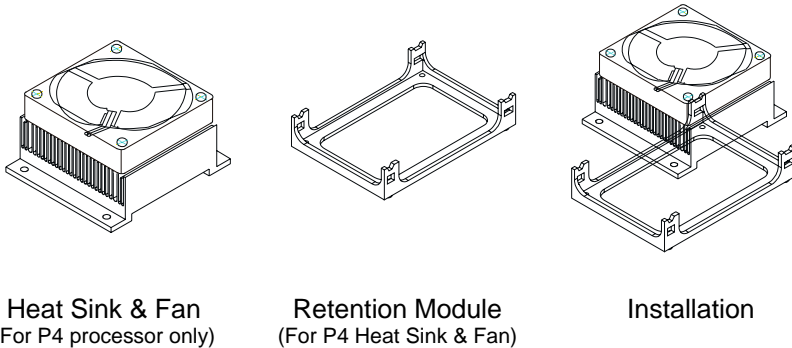

Figure 4: Heat Sink & Retention Module Installation

### 2.1.3 Memory Module Installation

Figure 5 display the notch marks and what they should look like on your DIMM memory module.

DIMMs have 184-pins and two notches, that will match with the onboard DIMM socket. DIMM modules are installed by placing the chip firmly into the socket at a 90-degree angle and pressing straight down (figure 6) until it fits tightly into the DIMM socket.

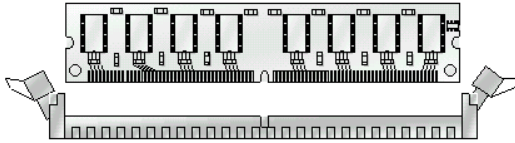

Figure 5: DIMM Memory and 184-pins Socket

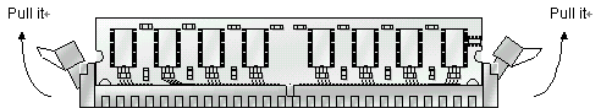

Figure 6: Memory Installation

## Installations

Carefully follow the steps below in order to install the DIMMs:

1. To avoid generating static electricity and damaging the DIMM, ground yourself by touching a grounded metal surface or using a ground scrap before you touch the DIMM.
2. Do not touch the connector of the DIMM. Dirt residue may cause a malfunction.
3. Hold the DIMM with its notch to the front side of the MBATX-845GV-VEAH Series and insert it completely into the socket. A DIMM should be inserted into the inner socket first. Guiding the hole at each end of the DIMM over the retaining post at each end of the DIMM socket.
4. If you install two DIMMs, install the second DIMM using the same procedure as above.
5. If DIMM does not go in smoothly, do not force it. Pull it all the way out and try again.
6. Make sure the DIMM is properly installed and locked by the tabs on both sides of the socket.

### **Removing a DIMM:**

To remove the DIMM, use your fingers or a small screwdriver to carefully push away the plastic tabs that secure the DIMM at each end. Lift it out of the socket.

**Make sure you store the DIMM in an anti-static bag and must be populated the same size and manufactory of memory modules.**



### 2.1.4 Setting Jumpers and DIP Switches

There are jumpers and DIP-switches on the system board of the MBATX-845GV-VEAH Series. You can set the jumpers to make the necessary operations.

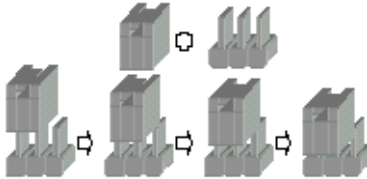
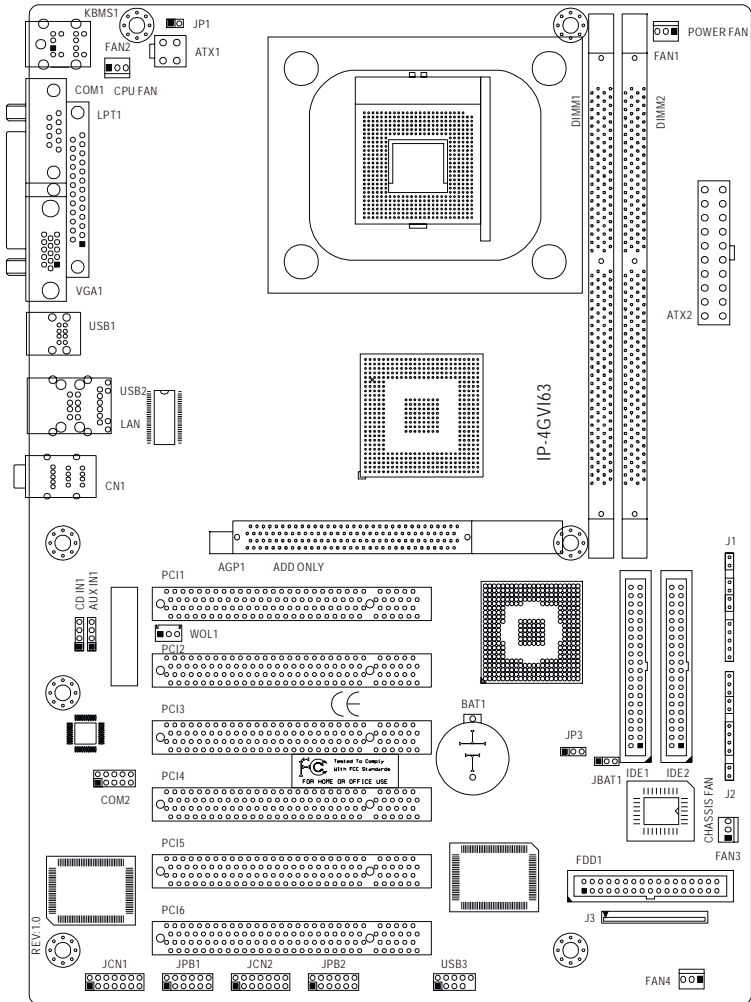

Figure 7: Jumper Connector

For any three-pins jumpers (Figure 7), the jumper setting is 1-2 when the jumper connects pin 1 and 2. The setting is 2-3 when pin 2 and 3 are connected and so on. You see a number “1” and a “3” printed on the circuit board to identify these pins. And also, there is a second way of indication – one of the lines surrounding jumpers is thick, which indicates pin NO.1.

To move a jumper from one position to another, use needle-nose pliers or tweezers to pull the pin cap off the pins and move it to the desired position.

## 2.2 Board Layout Jumper & Connector Location



## 2.3 Jumper Setting

### Table for Jumper Location Description:

Use the information in the following table to change the jumpers and the DIP switches.

<b>Jumpers</b>	<b>Functions</b>
JP1	CPU type select
JP3	Watchdog Timer setting select
JBAT1	Clear CMOS setting select
JPB1	COM3 port setting select
JPB2	COM4 port setting select

In order to set up the correct configuration, here is the description about how to set the jumpers to enable/disable or change functions. All jumpers' location please refer to jumper location diagram.

◆ **CPU type select: JP1**

Function	JP1
Regular P4 CPU (Default)	1-2 On
P4 Mobile CPU	1-2 Off

• **Location:**

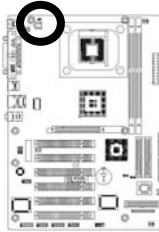

◆ **Watchdog Timer setting select: JP3**

Function	JP3
NMI (Default)	1-2
Reset System	2-3

• **Location:**

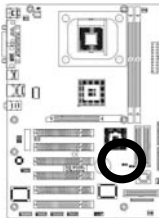

◆ **Clear CMOS setting select: JBAT1**

Function	JBAT1
Normal (Default)	1-2
Clear CMOS	2-3

• **Location:**

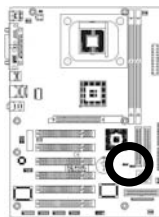

## ◆ COM3 port setting select: JPB1

Function	JPB1					
	1-2	3-4	5-6	7-8	9-10	11-12
RS-232	Off	Off	Off	Off	Off	On
RS-422	On (Term.)	On (Term.)	Off	On	On	Off
RS-485	On (Term.)	On (Term.)	On	Off	On	Off

## • Location:

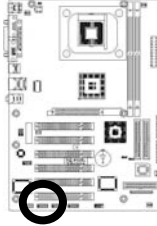

## ◆ COM4 port setting select: JPB2

Function	JPB2					
	1-2	3-4	5-6	7-8	9-10	11-12
RS-232	Off	Off	Off	Off	Off	On
RS-422	On (Term.)	On (Term.)	Off	On	On	Off
RS-485	On (Term.)	On (Term.)	On	Off	On	Off

## • Location:

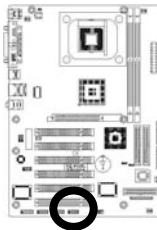

## 2.4 Connector's Description

### Connector Location

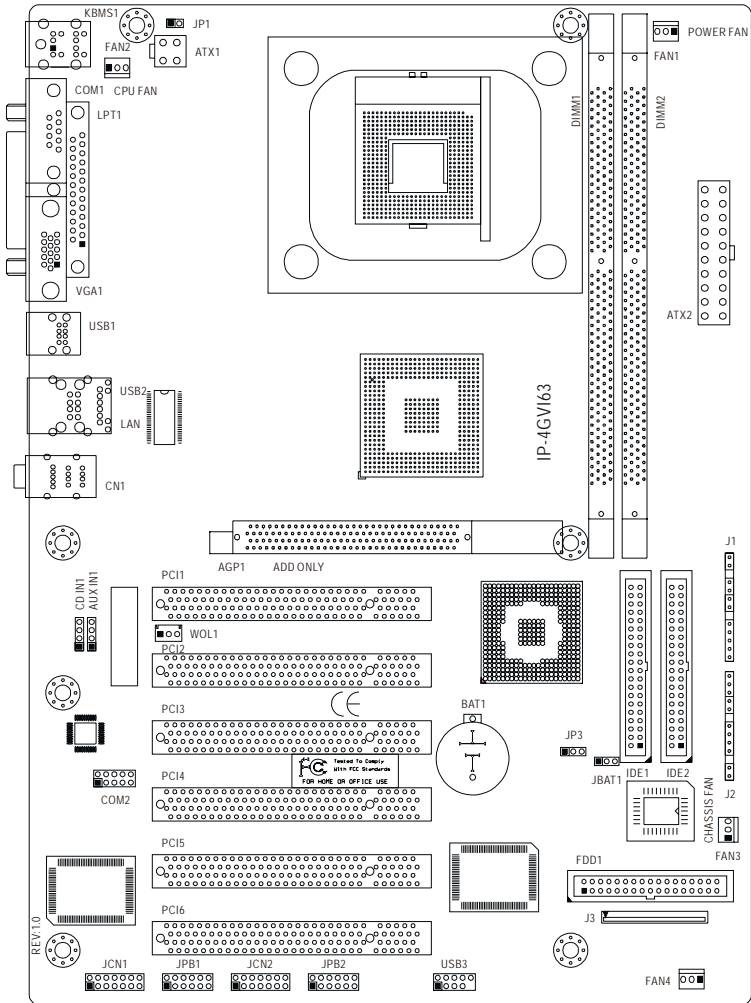

**Table for Connector's Location Description:**

Use the information in the following table to change the connector.

<b>Connectors</b>	<b>Functions</b>
IDE1	Primary IDE connector
IDE2	Secondary IDE connector
FDD1	Floppy disk connector
KBMS1	PS/2 keyboard & mouse connectors
COM1	COM1 RS-232 serial port connector
LPT1	Parallel port connector
VGA1	CRT VGA port connector
USB1	USB 1/2 connectors
USB2	USB 3/4 connectors
LAN	Ethernet RJ-45 connector
CN1	Audio port connector
CDIN1	CD_IN connector
AUXIN1	AUX_IN connector
WOL1	Wake On LAN connector
COM2	COM2 RS-232 serial port connector
JCN1	COM3 RS-232/422/485 serial port connector
JCN2	COM4 RS-232/422/485 serial port connector
USB3	USB 5/6 pin-header
FAN1/2/3/4	Power fan/CPU fan/Chassis fan/fan power connectors
ATX1	ATX 12V power connector
ATX2	ATX power connector
J1/J2	System panel indicate connectors
J3	Slim floppy disk connector

◆ **Primary IDE connector (40-pins 2.54mm pitch pin-header with housing): IDE1**

Pin #	Assignment	Pin #	Assignment
1	Reset IDE	2	Ground
3	Host Data 7	4	Host Data 8
5	Host Data 6	6	Host Data 9
7	Host Data 5	8	Host Data 10
9	Host Data 4	10	Host Data 11
11	Host Data 3	12	Host Data 12
13	Host Data 2	14	Host Data 13
15	Host Data 1	16	Host Data 14
17	Host Data 0	18	Host Data 15
19	Ground	20	---
21	DRQ 0	22	Ground
23	Host IOW	24	Ground
25	Host IOR	26	Ground
27	IOCHRDY	28	Host ALE
29	DACK 0	30	Ground
31	IRQ 14	32	No Connect
33	Address 1	34	No Connect
35	Address 0	36	Address 2
37	Chip Select 0	38	Chip Select 1
39	Activity	40	Ground

● **Figure:**

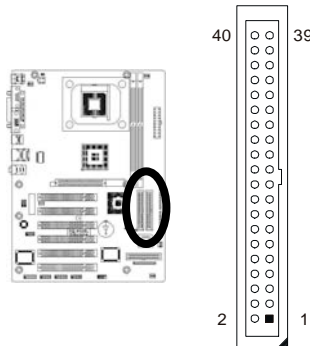



◆ **Secondary IDE connector (40-pins 2.54mm pitch pin-header with housing): IDE2**

Pin #	Assignment	Pin #	Assignment
1	Reset IDE	2	Ground
3	Host Data 7	4	Host Data 8
5	Host Data 6	6	Host Data 9
7	Host Data 5	8	Host Data 10
9	Host Data 4	10	Host Data 11
11	Host Data 3	12	Host Data 12
13	Host Data 2	14	Host Data 13
15	Host Data 1	16	Host Data 14
17	Host Data 0	18	Host Data 15
19	Ground	20	---
21	DRQ 1	22	Ground
23	Host IOW	24	Ground
25	Host IOR	26	Ground
27	IOCHRDY	28	Host ALE
29	DACK 1	30	Ground
31	IRQ 15	32	No Connect
33	Address 1	34	No Connect
35	Address 0	36	Address 2
37	Chip Select 0	38	Chip Select 1
39	Activity	40	Ground

● **Figure:**

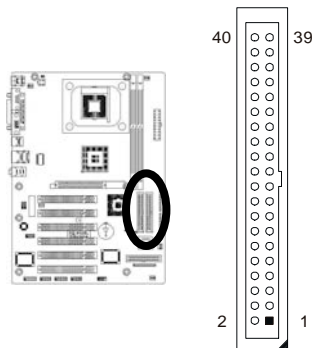

◆ Floppy disk connector (34-pins 2.54mm pitch pin-header with housing): FDD1

Pin #	Assignment	Pin #	Assignment
1	Ground	2	Drive Density Selection
3	Ground	4	NC
5	Ground	6	Drive Density Selection
7	Ground	8	Index
9	Ground	10	Motor Enable 0
11	Ground	12	Drive Select 1
13	Ground	14	Drive Select 0
15	Ground	16	Motor Enable 1
17	Ground	18	Direction
19	Ground	20	Step
21	Ground	22	Write Data
23	Ground	24	Write Gate
25	Ground	26	Track 00
27	Ground	28	Write Protect
29	NC	30	Read Data
31	Ground	32	Side 1 Select
33	NC	34	Diskette Change

• Figure:

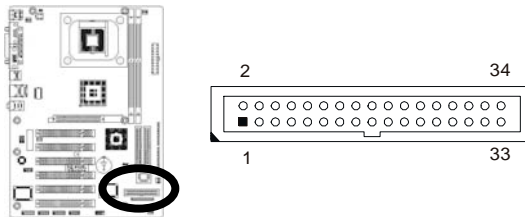

◆ **PS/2 keyboard connector (6-pins green Mini Din): KBMS1**

Pin #	Assignment	Pin #	Assignment
1	Keyboard data	2	NC
3	Ground	4	+5V
5	Keyboard clock	6	NC

• **Figure:**

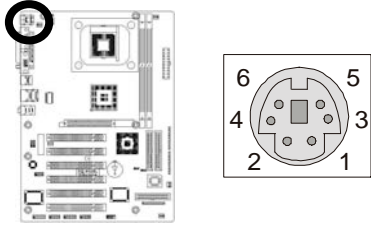

◆ **PS/2 mouse connector (6-pins purple Mini Din): KBMS1**

Pin #	Assignment	Pin #	Assignment
1	Mouse data	2	NC
3	Ground	4	+5V
5	Mouse clock	6	NC

• **Figure:**

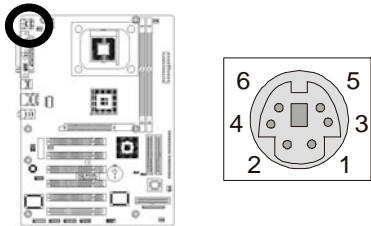

◆ **COM1 RS-232 serial port connector (D-Sub 9-pins male): COM1**

Pin #	Assignment	Pin #	Assignment
1	DCD (Data Carrier Detect)	6	DSR (Data Set Ready)
2	RXD (Receive Data)	7	RTS (Request to Send)
3	TXD (Transmit Data)	8	CTS (Clear to Send)
4	DTR (Data Terminal Ready)	9	RI (Ring Indicator)
5	Ground		

• **Figure:**

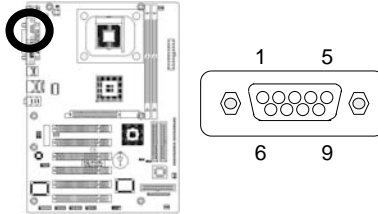

◆ **Parallel port connector (D-Sub 25-pins male): LPT1**

Pin #	Assignment	Pin #	Assignment
1	Line Printer Strobe	14	Auto Feed
2	PD 0, Parallel Data 0	15	Error
3	PD 1, Parallel Data 1	16	Initialize
4	PD 2, Parallel Data 2	17	Select
5	PD 3, Parallel Data 3	18	Ground
6	PD 4, Parallel Data 4	19	Ground
7	PD 5, Parallel Data 5	20	Ground
8	PD 6, Parallel Data 6	21	Ground
9	PD 7, Parallel Data 7	22	Ground
10	ACK, Acknowledge	23	Ground
11	Busy	24	Ground
12	Paper Empty	25	Ground
13	Select	26	---

• **Figure:**

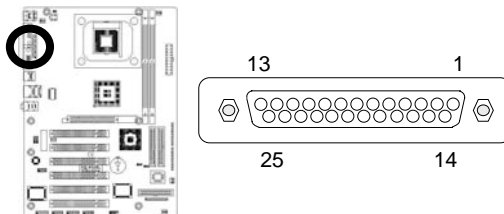

◆ **CRT VGA port connector (D-SUB 15-pins female): VGA1**

Pin #	Assignment	Pin #	Assignment
1	Red	2	Green
3	Blue	4	NC
5	Ground	6	Ground
7	Ground	8	Ground
9	VCC	10	Ground
11	NC	12	DDData
13	HSync	14	VSync
15	DDClk		

• **Figure:**

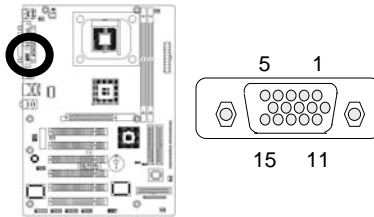

◆ **USB 1/2 connectors (4-pins female): USB1**

Pin #	Assignment	Pin #	Assignment
1a	VCC	1b	VCC
2a	USB1 -	2b	USB2 -
3a	USB1 +	3b	USB2 +
4a	Signal ground	4b	Signal ground

• **Figure:**

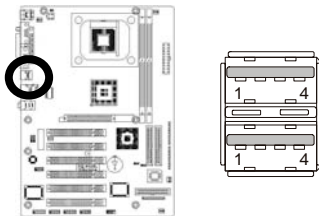

◆ **USB 3/4 connectors (4-pins female): USB2**

Pin #	Assignment	Pin #	Assignment
1a	VCC	1b	VCC
2a	USB3 -	2b	USB4 -
3a	USB3 +	3b	USB4 +
4a	Signal ground	4b	Signal ground

● **Figure:**

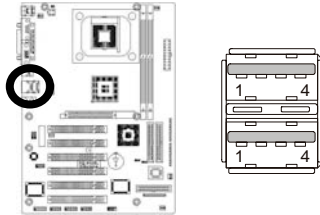

◆ **Ethernet (82562ET) RJ-45 connector (RJ-45 phone-jack): LAN**

Pin #	Assignment	Pin #	Assignment
1	Transmit output (+)	5	NC
2	Transmit output (-)	6	Receive input (-)
3	Receive input (+)	7	NC
4	NC	8	NC

● **Figure:**

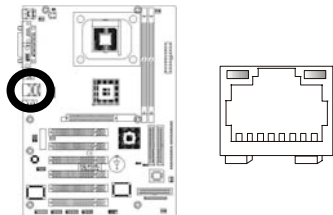

◆ **Audio port connector: CN1**

Pin #	Assignment
Blue	Line-In
Green	Line-Out
Red	Mic-In

• **Figure:**

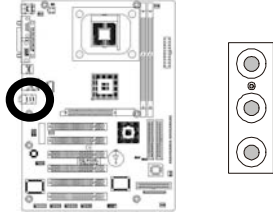

◆ **CD\_IN connector: CDIN1**

Pin #	Assignment
1	CD_IN_Left
2	CD_Ground
3	CD_Ground
4	CD_IN_Right

• **Figure:**

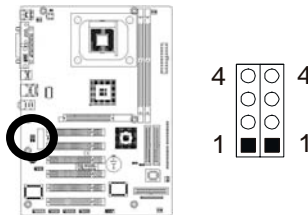

◆ **AUX\_IN connector: AUXIN1**

Pin #	Assignment
1	Left Line_IN
2	Ground
3	Ground
4	Right Line_IN_

• **Figure:**

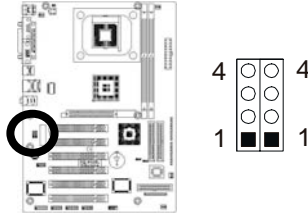

◆ **Wake On LAN connector: WOL1**

Pin #	Assignment
1	5VSB
2	Ground
3	Data

• **Figure:**

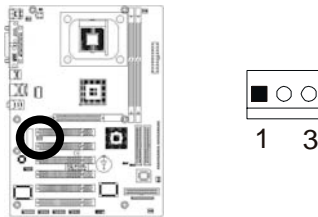



◆ **COM2 RS-232 serial port connector (10-pins pin-header): COM2**

Pin #	Assignment	Pin #	Assignment
1	DCD (Data Carrier Detect)	2	DSR (Data Set Ready)
3	RXD (Receive Data)	4	RTS (Request to Send)
5	TXD (Transmit Data)	6	CTS (Clear to Send)
7	DTR (Data Terminal Ready)	8	RI (Ring Indicator)
9	Ground	10	Ground

• **Figure:**

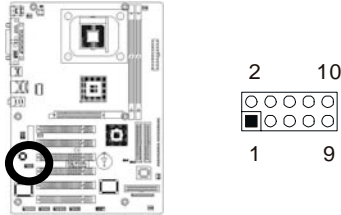

◆ **COM3 RS-232/422/485 serial port connector (14-pins pin-header): JCN1**

Pin #	Assignment	Pin #	Assignment
1	DCD (Data Carrier Detect)	2	DSR (Data Set Ready)
3	RXD (Receive Data)	4	RTS (Request to Send)
5	TXD (Transmit Data)	6	CTS (Clear to Send)
7	DTR (Data Terminal Ready)	8	RI (Ring Indicator)
9	Ground	10	Ground
11	TXD+ (Transmit Data+)	12	TXD- (Transmit Data-)
13	RXD+ (Receive Data+)	14	RXD- (Receive Data-)

• **COM3 Figure:**

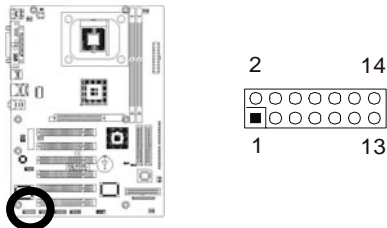

◆ **COM4 RS-232/422/485 serial port connector (14-pins pin-header): JCN2**

Pin #	Assignment	Pin #	Assignment
1	DCD (Data Carrier Detect)	2	DSR (Data Set Ready)
3	RXD (Receive Data)	4	RTS (Request to Send)
5	TXD (Transmit Data)	6	CTS (Clear to Send)
7	DTR (Data Terminal Ready)	8	RI (Ring Indicator)
9	Ground	10	Ground
11	TXD+ (Transmit Data+)	12	TXD- (Transmit Data-)
13	RXD+ (Receive Data+)	14	RXD- (Receive Data-)

● **COM4 Figure:**

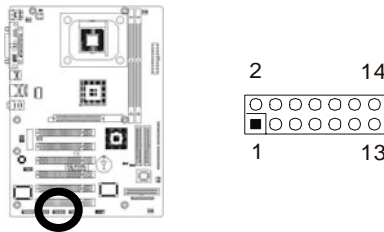

**Note: How to connect RS485 device with COM port ribbon cable?**

Our Industrial Board encloses a COM port ribbon cable for internal connection. RS422/485 device must connect to downside D-Sub with 5-pins cable and signal indication as below.

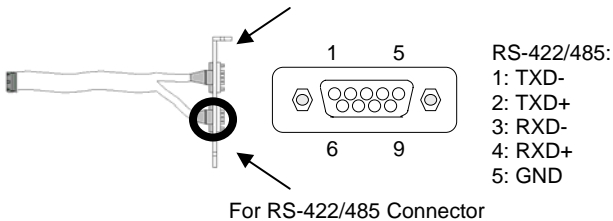

◆ **USB 5/6 pin-header (9-pins pin-header): USB3**

Pin #	Assignment	Pin #	Assignment
1	VCC	2	VCC
3	USB5 -	4	USB6 -
5	USB5 +	6	USB6 +
7	Ground	8	Ground
9	---	10	NC

• **Figure:**

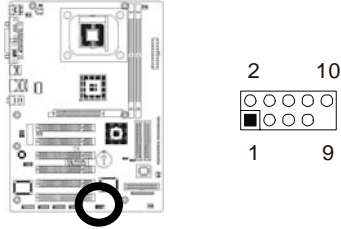

◆ **Power fan power connector: FAN1**

Pin #	Assignment
1	Ground
2	+12V
3	Sense

• **Figure:**

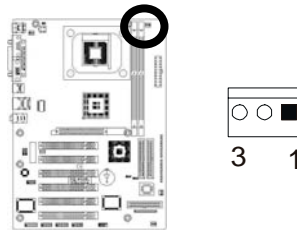

◆ CPU fan power connector: FAN2

Pin #	Assignment
1	Ground
2	+12V
3	Sense

• Figure:

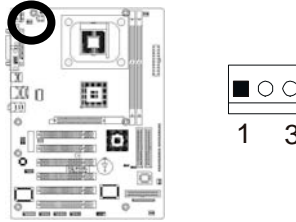

◆ Chassis fan power connector: FAN3

Pin #	Assignment
1	Ground
2	+12V
3	Sense

• Figure:

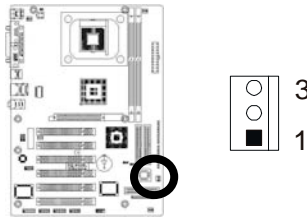

◆ Fan power connector: FAN4

Pin #	Assignment
1	Ground
2	+12V
3	Sense

• Figure:

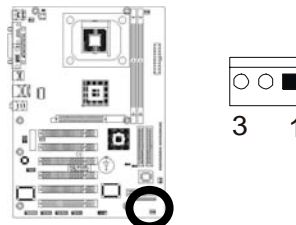

◆ **ATX 12V power connector: ATX1**

Pin #	Assignment	Pin #	Assignment
1	Ground	2	Ground
3	+12V	4	+12V

● **Figure:**

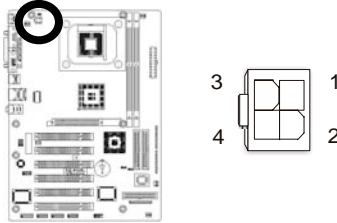

◆ **ATX power connector: ATX2**

Pin #	Assignment	Pin #	Assignment
1	+3.3V	11	+3.3V
2	+3.3V	12	-12V
3	Ground	13	Ground
4	+5V	14	PS-ON
5	Ground	15	Ground
6	+5V	16	Ground
7	Ground	17	Ground
8	PW-OK	18	-5V
9	5VSB	19	+5V
10	+12V	20	+5V

● **Figure:**

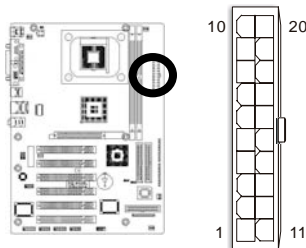

◆ System panel indicate connector: J1 & J2

Pin #	J1 Assignment	Pin #	J2 Assignment
<b>IR</b>		<b>RESET</b>	
1	+5V	1	RESET+
2	FIRTX	2	Ground
3	IRRX	<b>SPEAKER</b>	
4	Ground	4	SPEAKER
5	IRTX	5	NC
<b>HDD LED</b>		6	Ground
7	HDLED+	7	+5V
8	HDLED-	<b>PWR LED</b>	
<b>TB LED</b>		9	PWLED+
9	TBLED+	10	NC
10	TBLED-	11	PWLED-
<b>PWR ON</b>		<b>KEYLOCK</b>	
12	PWRBT+	12	KBLOCK
13	PWRBT-	13	Ground

● Figure:

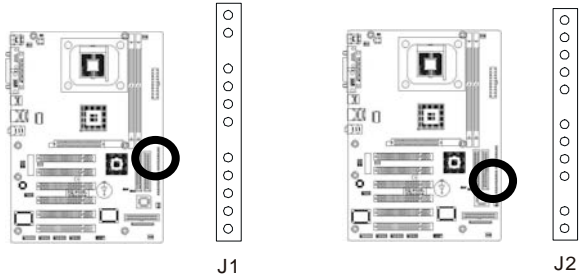

◆ Slim floppy disk connector (26-pins FPC connector): J3

Pin #	Assignment	Pin #	Assignment
1	+5V	14	Step
2	Index	15	Ground
3	+5V	16	Write_Data
4	Drive_Select	17	Ground
5	+5V	18	Write_Gate
6	Disk_Change	19	Ground
7	NC	20	Track
8	Ready	21	Ground
9	HD_Out	22	Write_Protect
10	Motor_On	23	Ground
11	Reserve	24	Read_Data
12	Direction	25	Ground
13	NC	26	Side_One

● Figure:

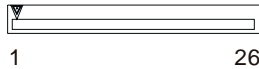
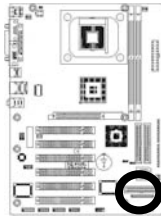

The graphic consists of three overlapping rectangular boxes, each containing the text 'SECTION 3'. The boxes are stacked and slightly offset to the right, creating a layered effect.

## SECTION 3

# **AWARD BIOS SETUP**

## **3.1 BIOS Instructions**

Award's ROM BIOS provides a built-in Setup program, which allows user to modify the basic system configuration and hardware parameters. The modified data will be stored in a battery-backed CMOS, so that data will be retained even when the power is turned off. In general, the information saved in the CMOS RAM will stay unchanged unless there is a configuration change in the system, such as hard drive replacement or a device is added.

It is possible for the CMOS battery to fail, this will cause data loss in the CMOS only. If this does happen you will need to reconfigure your BIOS settings.



### 3.2 Main Menu

Once you enter the AwardBIOS™ CMOS Setup Utility, the Main Menu will appear on the screen. The Main Menu allows you to select from several setup functions and two exit choices. Use the arrow keys to select among the items and press <Enter> to accept and enter the sub-menu.

Phoenix - AwardBIOS CMOS Setup Utility	
Standard CMOS Feature	Frequency/Voltage Control
Advanced BIOS Feature	Load Fail-Safe Defaults
Advanced Chipset Feature	Load Optimized Defaults
Integrated Peripherals	Set Supervisor Password
Power Management Setup	Set User Password
PnP/PCI Configurations	Save & Exit Setup
PC Health Status	Exit Without Saving
Esc: Quit	
↑ ↓ ← →: Select Item	
F10: Save & Exit Setup	
Time, Date, Hard Disk Type....	

Note: that a brief description of each highlighted selection appears at the bottom of the screen.

#### Setup Items:

The main menu includes the following main setup categories. Recall that some systems may not include all entries.

#### Standard CMOS Features:

Use this menu for basic system configuration. See Section 2 for the details.

#### Advanced BIOS Features:

Use this menu to set the Advanced Features available on your system. See Section 3 for the details.

#### Advanced Chipset Features:

Use this menu to change the values in the chipset registers and optimize your system's performance. See section 4 for the details.

**Integrated Peripherals:**

Use this menu to specify your settings for integrated peripherals. See section 4 for the details.

**Power Management Setup:**

Use this menu to specify your settings for power management. See section 5 for the details.

**PnP / PCI Configuration:**

This entry appears if your system supports PnP / PCI. See section 6 for the details.

**PC Health Status:**

Use this menu to show your system temperature, speed and voltage status.

**Frequency/Voltage Control:**

Use this menu to specify your settings for frequency/voltage control. See section 7 for the details.

**Load Fail-Safe Defaults:**

Use this menu to load the BIOS default values for the minimal/stable performance for your system to operate. See section 8 for the details.

**Load Optimized Defaults:**

Use this menu to load the BIOS default values that are factory settings for optimal performance system operations. While Award has designed the custom BIOS to maximize performance, the factory has the right to change these defaults to meet their needs. See section 8 for the details.

**Set Supervisor / User Password:**

Use this menu to set User and Supervisor Passwords. See section 9 for the details.

**Save & Exit Setup:**

Save CMOS value changes to CMOS and exit setup. See section 10 for the details.

**Exit Without Save:**

Abandon all CMOS value changes and exit setup. See section 10 for the details.

### 3.3 Standard CMOS Features

The items in Standard CMOS Setup Menu are divided into 10 categories. Each category includes no, one or more than one setup items. Use the arrow keys to highlight the item and then use the <PgUp> or <PgDn> keys to select the value you want in each item.

Phoenix - AwardBIOS CMOS Setup Utility  
Standard CMOS Features

Date: (mm:dd:yy)	Wed, Aug 5 2003	Item Help
Time: (hh:mm:ss)	16:19:20	
➤ IDE Primary Master	2557 MB	—
➤ IDE Primary Slave	None	Menu Level ➤
➤ IDE Secondary Master	None	Change the day, month, year and century
➤ IDE Secondary Slave	None	
Drive A	1.44M, 3.5 in.	
Drive B	None	
Video	EGA/VGA	
Halt On	All, But Keyboard	
Based Memory	640K	
Extended Memory	130048K	
Total Memory	131072K	
↑↓←→Move Enter: Select +/-/PU/PD: Value F10: Save ESC: Exit F1: General Help F5: Previous Values F6: Fail-safe defaults F7: Optimized Defaults		

**Date:** Options Month/DD/YYYY

Set the system date. Note that the 'Day' automatically changes when you set the date.

**Time:** Options HH : MM : SS

Set the system time.

**IDE Primary Master:** Options are in its sub menu (described in 3.4)

Press <Enter> to enter the sub menu of detailed options.

**IDE Primary Slave:** Options are in its sub menu (described in 3.4)

Press <Enter> to enter the sub menu of detailed options.

**IDE Secondary Master:** Options are in its sub menu (described in 3.4)  
Press <Enter> to enter the sub menu of detailed options.

**IDE Secondary Master:** Options are in its sub menu (described in 3.4)  
Press <Enter> to enter the sub menu of detailed options.

**Drive A/ Drive B:** Options None 360K, 5.25 in/1.2M, 5.25 in/720K, 3.5 in/  
1.44M, 3.5 in/2.88M, 3.5 in  
Select the type of floppy disk drive installed in your system.

**Video:** Options EGA/VGA/CGA 40/CGA 80/MONO  
Select the default video device.

**Halt On:** Options All Errors/No Errors/All, but Keyboard/All, but Diskette/All,  
but Disk/Key  
Select the situation in which you want the BIOS to stop the POST process  
and notify you.

**Base Memory:** Option N/A  
Displays the amount of conventional memory detected during boot up.

**Extended Memory:** Option N/A  
Displays the amount of extended memory detected during boot up

**Total Memory:** Option N/A  
Displays the total memory available in the system

### 3.4 IDE Adapters

The IDE adapters control the hard disk drive. Use a separate sub menu to configure each hard disk drive.

Phoenix - AwardBIOS CMOS Setup Utility

IDE Primary Master

IDE HDD Auto-Detection	<b>Press Enter</b>	Item Help
IDE Primary Master Access Mode	Auto 2557 MB Auto	Menu Level >>
Cylinder	4956	To auto-detect the HDD's size, head... on this channel
Head	16	
Precomp	0	
Landing Zone	4955	
Sector	63	
↑↓←→Move Enter: Select +/-/PU/PD: Value F10: Save ESC: Exit F1: General Help F5: Previous Values F6: Fail-safe defaults F7: Optimized Defaults		

#### **IDE HDD Auto-detection:** Options Press Enter

Press Enter to auto-detect the HDD on this channel. If detection is successful, it fills the remaining fields on this menu.

#### **IDE Primary Master:** Options None, Auto and Manual

Selecting "Manual" lets you set the remaining fields on this screen. Selects the type of fixed disk. "User Type" will let you select the number of cylinders, heads, etc. Note: PRECOMP=65535 means NONE !

#### **Access Mode:** Options CHS, LBA, Large and Auto

Choose the access mode for this hard disk

## Award BIOS Setup

The following options are selectable only if the 'IDE Primary Master' item is set to "Manual"

**Cylinder:** Options Min = 0, Max = 65535

Set the number of cylinders for this hard disk.

**Head:** Options Min = 0, Max = 255

Set the number of read/write heads

**Precomp:** Options Min = 0, Max = 65535

\*\*\*\* **Warning:** Setting a value of 65535 means no hard disk

**Landing zone:** Options Min = 0, Max = 65535

\*\*\*\*

**Sector:** Options Min = 0, Max = 255

Number of sectors per track

### 3.5 Advanced BIOS Features

This section allows you to configure your system for basic operation. You have the opportunity to select the system's default speed, boot-up sequence, keyboard operation, shadowing and security.

Phoenix - AwardBIOS CMOS Setup Utility  
Advanced BIOS Features

Virus Warning	Disabled	Item Help <hr/> Menu Level >
CPU L1 & L2 Cache	Enabled	
Quick Power On Self Test	Enabled	
APIC Mode	Disabled	
HDD S.M.A.R.T. Capability	Disabled	
➤ Boot Seq. & Floppy Setup	Press Enter	
Boot Up NumLock Status	On	
Gate A20 Option	Fast	
Typematic Rate Setting	Disabled	
X Typematic Rate (Chars/Sec)	6	
X Typematic Delay (Msec)	250	
Security Option	Setup	
OS Select For DRAM > 64MB	Non-OS2	
↑↓←→Move Enter: Select +/-/PU/PD: Value F10: Save ESC: Exit F1: General Help F5: Previous Values F6: Fail-safe defaults F7: Optimized Defaults		

#### Virus Warning:

Allow you to choose the VIRUS Warning feature for IDE Hard Disk boot sector protection. If this function is enabled and someone attempt to write data into this area, BIOS will show a warning message on screen and alarm beep.

Enabled---Activates automatically when the system boots up causing a warning message to appear when anything attempts to access the boot sector or hard disk partition table.

Disabled---No warning message will appear when anything attempts to access the boot sector or hard disk partition table.

#### CPU L1 & L2 Cache:

These two categories speed up memory access. However, it depends on CPU/chipset design.

Enabled---Enable cache

Disabled---Disable cache

**Quick Power On Self Test:**

This category speeds up Power On Self Test (POST) after you power up the computer. If it is set to Enable, BIOS will shorten or skip some check items during POST.

Enabled---Enable quick POST

Disabled--- Normal POST

**APIC Mode:**

This item allows you to enable/disable APIC Mode.

The choice: Enabled, Disabled.

**HDD S.M.A.R.T Capability:**

Enabled SMART hard driver functions for compatible. The default is disabled.

The choice: Enabled, Disabled.

**Boot Seq. & Floppy Setup:**

Phoenix - AwardBIOS CMOS Setup Utility

Boot Seq. & Floppy Setup

First Boot Device	Floppy	Item Help
Second Boot Device	HDD-0	
Third Boot Device	SCSI	
Boot Other Device	Enabled	Menu Level >
Swap Floppy Drive	Disabled	
Boot Up Floppy Seek	Enabled	Select your Boot Device Priority
Report NO FDD For Win 95	No	
↑↓←→Move Enter: Select +/-/PU/PD: Value F10: Save ESC: Exit F1: General Help		
F5: Previous Values F6: Fail-safe defaults F7: Optimized Defaults		

**First/Second/Third Boot Device:**

The BIOS attempts to load the operating system from the devices in the sequence selected in these items.

The Choice: Floppy, LS/ZIP, HDD, SCSI, CDROM, LAN and Disabled.

**Boot Other Device:**

When enabled, the system searches all other possible locations for an operating system if it fails to find one in the devices specified under the first, second, and third boot devices.

The Choice: Enabled, Disabled



**Swap Floppy Drive:**

If the system has two floppy drives, you can swap the logical drive name assignments.

The choice: Enabled, Disabled.

**Boot Up Floppy Seek:**

Seeks disk drives during boot up. Disabling speeds boot up.

The choice: Enabled, Disabled.

**Report No FDD For Win 95:**

Whether report no FDD for Win 95 or not.

The choice: Yes, No.

**Boot Up NumLock Status:**

Select power on state for NumLock.

The choice: Off, On

**Gate A20 Option:**

Select if chipset or keyboard controller should control GateA20.

Normal---A pin in the keyboard controller controls GateA20

Fast---Lets chipset control GateA20

**Typematic Rate Setting:**

Keystrokes repeat at a rate determined by the keyboard controller. When enabled, the typematic rate and typematic delay can be selected.

The choice: Enabled/Disabled.

**Typematic Rate (Chars/Sec):**

Sets the number of times a second to repeat a keystroke when you hold the key down.

The choice: 6, 8, 10, 12, 15, 20, 24 and 30.

**Typematic Delay (Msec):**

Sets the delay time after the key is held down before it begins to repeat the keystroke.

The choice: 250, 500, 750 and 1000.

**Security Option:**

Select whether the password is required every time the system boots or only when you enter setup.

System---The system will not boot and access to Setup will be denied if the correct password is not entered at the prompt.

Setup---The system will boot, but access to Setup will be denied if the correct password is not entered at the prompt.

Note: To disable security, select PASSWORD SETTING at Main Menu and then you will be asked to enter password. Do not type anything and just press <Enter>, it will disable security. Once the security is disabled, the system will boot and you can enter Setup freely.

**OS Select For DRAM > 64MB:**

Select the operating system that is running with greater than 64MB of RAM on the system.

The choice: Non-OS2, OS2.

### 3.6 Advanced Chipset Features

This section allows you to configure the system based on the specific features of the installed chipset. This chipset manages bus speeds and access to system memory resources, such as DRAM and the external cache. It also coordinates communications between the conventional ISA bus and the PCI bus. It must be stated that these items should never need to be altered. The default settings have been chosen because they provide the best operating conditions for your system. The only time you might consider making any changes would be if you discovered that data was being lost while using your system.

Phoenix - AwardBIOS CMOS Setup Utility  
Advanced Chipset Features

Item	By SPD	Item Help
DRAM Timing Selectable	By SPD	
X CAS Latency Time	2.5	
X Active To Precharge Delay	6	
X DRAM RAS# To CAS# Delay	3	Menu Level >
X DRAM RAS# Precharge	3	
System BIOS Cacheable	Enabled	
Video BIOS Cacheable	Disabled	
Delayed Transaction	Enabled	
Command Per Clock	Auto	
Fast CS#	Auto	
Delay Prior To Thermal	16Min.	
AGP Aperture Size (MB)	64	
** On-Chip VGA Setting **		
On-Chip VGA	Enabled	
On-Chip Frame Buffer Size	8MB	
Boot Display	Auto	
TV Format	Auto	
↑↓←→Move Enter: Select +/-/PU/PD: Value F10: Save ESC: Exit F1: General Help F5: Previous Values F6: Fail-safe defaults F7: Optimized Defaults		

#### DRAM Timing Selectable:

Select the operating system that is selecting DRAM timing, so select SPD for setting SDRAM timing by SPD.

The choice: Manual, SPD, Turbo.

**CAS Latency Time:**

When synchronous DRAM is installed, the number of clock cycles of CAS latency depends on the DRAM timing.

The choice: 1.5, 2, and 2.5.

**Active To Precharge Delay:**

Select the operating system that is active to precharge delay.

The choice: 5, 6, 7.

**DRAM RAS# To CAS# Delay:**

This field let's you insert a timing delay between the CAS and RAS strobe signals, used when DRAM is written to, read from, or refreshed. Fast gives faster performance; and Slow gives more stable performance. This field applies only when synchronous DRAM is installed in the system.

The choice: 2, 3.

**DRAM RAS# Precharge:**

If an insufficient number of cycles are allowed for the RAS to accumulate its charge before DRAM refresh, the refresh may be incomplete and the DRAM may fail to retain data. Fast gives faster performance; and Slow gives more stable performance. This field applies only when synchronous DRAM is installed in the system.

The choice: 2, 3.

**System BIOS Cacheable:**

Selecting "Enabled" allows caching of the system BIOS ROM at F0000h-FFFFFh, resulting in better system performance. However, if any program writes to this memory area, a system error may result.

The choice: Enabled, Disabled.

**Video BIOS Cacheable:**

Select "Enabled" allows caching of the video BIOS, resulting in better system performance. However, if any program writes to this memory area, a system error may result.

The choice: Enabled, Disabled.

**Delayed Transaction:**

The chipset has an embedded 32-bit posted write buffer to support delay transactions cycles. Select "Enabled" to support compliance with PCI specification version 2.1.

The choice: Enabled, Disabled.

**Command Per Clock:**

Select this item allows the command per clock for system.

The choice: Auto, Enabled, Disabled.

**Fast CS#:**

Select this item allows the Fast CS# function.

The choice: Auto, Enabled, Disabled.

**Delay Prior To Thermal:**

Select this item allows the delay prior to thermal time.

The choice: 4, 8, 16, 32 Min.

**AGP Aperture Size (MB):**

This field determines the effective size of the Graphic Aperture used for a particular GMCH configuration. It can be updated by the GMCH-specific BIOS configuration sequence before the PCI standard bus enumeration sequence takes place. If it is not updated then a default value will select an aperture of maximum size.

The choice: 4, 8, 16, 32, 64, 128 and 256

**On-Chip VGA**

Select this item allows you to control the on-chip VGA.

The choice: Enabled, Disabled.

**On-Chip Frame Buffer Size:**

Select this item allows you to control the on-chip frame buffer size.

The choice: 1MB, 8MB.

**Boot Display:**

Select this item allows you to set the boot display device.

The choice: Auto, CRT, TV, EFP.

**TV Format:**

Select this item allows you to set the TV format.

### 3.7 Integrated Peripherals

Phoenix - AwardBIOS CMOS Setup Utility

#### Integrated Peripherals

<ul style="list-style-type: none"> <li>➤ Onboard IDE Device Setup      Press Enter</li> <li>➤ Onboard PCI Device Setup      Press Enter</li> <li>➤ Onboard I/O Chip Setup        Press Enter</li> <li>  Init Display First              Onboard AGP</li> <li>  Onboard Serial Port 3          3E8</li> <li>  Serial Port 3 Use IRQ          IRQ10</li> <li>  Onboard Serial Port 4          2E8</li> <li>  Serial Port 4 Use IRQ          IRQ11</li> <li>  Intel LAN Boot ROM            Disabled</li> </ul>	<p>Item Help</p> <hr/> <p>Menu Level   ➤</p>
<p>↑↓←→Move    Enter: Select   +/-/PU/PD: Value   F10: Save   ESC: Exit   F1: General Help          F5: Previous Values   F6: Fail-safe defaults   F7: Optimized Defaults</p>	

#### Onboard IDE Device Setup:

Phoenix - AwardBIOS CMOS Setup Utility

#### Onboard IDE Device Setup

<ul style="list-style-type: none"> <li>On-Chip Primary PCI IDE        Enabled</li> <li>IDE Primary Master PIO        Auto</li> <li>IDE Primary Slave PIO         Auto</li> <li>IDE Primary Master UDMA       Auto</li> <li>IDE Primary Slave UDMA       Auto</li> <li>On-Chip Secondary PCI IDE    Enabled</li> <li>IDE Secondary Master PIO      Auto</li> <li>IDE Secondary Slave PIO       Auto</li> <li>IDE Secondary Master UDMA    Auto</li> <li>IDE Secondary Slave UDMA     Auto</li> <li>IDE HDD Block Mode            Enabled</li> </ul>	<p>Item Help</p> <hr/> <p>Menu Level   ➤</p>
<p>↑↓←→Move    Enter: Select   +/-/PU/PD: Value   F10: Save   ESC: Exit   F1: General Help          F5: Previous Values   F6: Fail-safe defaults   F7: Optimized Defaults</p>	

#### On-Chip Primary/Secondary PCI IDE:

The integrated peripheral controller contains an IDE interface with support for two IDE channels. Select "Enabled" to activate each channel separately.

The choice: Enabled, Disabled.

**IDE Primary/Secondary Master/Slave PIO:**

The four IDE PIO (Programmed Input/Output) fields let you set a PIO mode (0-4) for each of the four IDE devices that the onboard IDE interface supports. Modes 0 through 4 provide successively increased performance. In Auto mode, the system automatically determines the best mode for each device.

The choice: Auto, Mode 0, Mode 1, Mode 2, Mode 3 and Mode 4.

**IDE Primary/Secondary Master/Slave UDMA:**

Ultra DMA/33 implementation is possible only if your IDE hard drive supports it and the operating environment includes a DMA driver (Windows 95 OSR2 or a third-party IDE bus master driver). If your hard drive and your system software both support Ultra DMA/33, select "Auto" to enable BIOS support.

The choice: Auto, Disabled.

**IDE HDD Block Mode:**

Block mode is also called block transfer, multiple commands, or multiple sector read/write. If your IDE hard drive supports block mode (most new drives do), select Enabled for automatic detection of the optimal number of block read/writes per sector the drive can support.

The choice: Enabled, Disabled

**Onboard PCI Device Setup:**

Phoenix - AwardBIOS CMOS Setup Utility

Onboard PCI Device Setup

USB Controller	Enabled	Item Help <hr/> Menu Level >
USB 2.0 Controller	Enabled	
USB Keyboard Support	Auto	
USB Mouse Support	Disabled	
AC97 Audio	Auto	
Onboard LAN Controller	Enabled	
↑↓←→Move Enter: Select +/-/PU/PD: Value F10: Save ESC: Exit F1: General Help F5: Previous Values F6: Fail-safe defaults F7: Optimized Defaults		

**USB/USB 2.0 Controller:**

Select "Enabled" if your system contains a USB/USB2.0 controller and you have USB peripherals.

The choice: Enabled, Disabled.

**USB Keyboard Support:**

Select "Enabled" if your system contains a Universal Serial Bus (USB) controller and you have a USB keyboard.

The choice: Enabled, Disabled.

**USB Mouse Support:**

Select "Enabled" if your system contains a Universal Serial Bus (USB) controller and you have a USB mouse.

The choice: Enabled, Disabled.

**AC97 Audio:**

This item allows you to auto or disable to support AC97 Audio.

The choice: Auto, Disabled.

**Onboard LAN Controller:**

Select "Enabled" to Enables the onboard LAN feature.

The choice: Enabled, Disabled.

**Onboard I/O Chip Setup:**

Phoenix - AwardBIOS CMOS Setup Utility

Onboard I/O Chip Setup

	Hot Key	Item Help
Power ON Function	Hot Key	
Hot Key Power ON	Ctrl-F1	
Onboard FDC Controller	Enabled	
Onboard Serial Port 1	3F8/IRQ4	
Onboard Serial Port 2	2F8/IRQ3	
UART Mode Select	Normal	
X Rx/D, Tx/D Active	Hi, Lo	
X IR Transmission Delay	Enabled	
X UR2 Duplex Mode	Half	
X Use IR Pins	IR-Rx2Tx2	
Onboard Parallel Port	378/IRQ7	
Parallel Port Mode	SPP	
X EPP Mode Select	EPP1.7	
X ECP Mode Use DMA	3	
PWRON After PWR-Fail	Off	
<p>Menu Level &gt;</p> <p>If your IDE hard drive supports block mode select Enabled for automatic detection of the optimal number of block read/write per sector the drive can support</p>		
<p>↑↓←→Move Enter: Select +/-/PU/PD: Value F10: Save ESC: Exit F1: General Help                      F5: Previous Values F6: Fail-safe defaults F7: Optimized Defaults</p>		

**Power On Function:**

You can use this item to select operating Power On the system.

The choice: Button Only, Hot Key



**Hot Key Power ON:**

You can use this item to select operating Hot Key to Power On system.

The choice: Ctrl-F1

**Onboard FDC Controller:**

Select "Enabled" if your system has a floppy disk controller (FDC) installed on the system board and you wish to use it. If you install and-in FDC or the system has no floppy drive, select Disabled in this field.

The choice: Enabled, Disabled.

**Onboard Serial Port 1/Port 2:**

Select an address and corresponding interrupt for the first and second serial ports.

The choice: 3F8/IRQ4, 2E8/IRQ3, 3E8/IRQ4, 2F8/IRQ3, Disabled and Auto.

**UART Mode Select:**

This item allows you to select UART mode.

The choice: IrDA, ASKIR and Normal.

**RxD, TxD Active:**

This item allows you to determine the active of RxD, TxD.

The Choice: "Hi, Hi", "Lo, Lo", "Lo, Hi" and "Hi, Lo".

**IR Transmission Delay:**

This item allows you to enable/disable IR transmission delay.

The choice: Enabled, Disabled.

**UR2 Duplex Mode:**

This item allows you to select the IR half/full duplex function.

The choice: Half, Full.

**Use IR Pins:**

This item allows you to select IR transmission routes, one is RxD2m, TxD2 (COM Port) and the other is IR-Rx2Tx2.

The choice: IR-Rx2Tx2, RxD2 and TxD2.

**Onboard Parallel Port:**

This item allows you to determine access onboard parallel port controller with which I/O address.

The choice: 3BC/IRQ7, 378/IRQ7, 278/IRQ5 and Disabled.

**Parallel Port Mode:**

Select an operating mode for the onboard parallel (printer) port. Select Normal, Compatible, or SPP unless you are certain your hardware and software both support one of the other available modes.

The choice: SPP, EPP, ECP and ECP+EPP.

**EPP Mode Select:**

Select EPP port type 1.7 or 1.9.

The choice: EPP1.7, 1.9.

**ECP Mode Use DMA:**

Select a DMA channel for the parallel port for use during ECP mode.

The choice: 3, 1.

**PWRON After PWR-Fail:**

This item allows you to select if you want to power on the system after power failure.

The choice: Off, On and Former-Sts.

**Init Display First:**

This item allows you to decide to active whether PCI Slot or on-chip VGA first.

The choice: PCI Slot, Onboard.

**Onboard Serial Port 3/Port4:**

Select an address for the third and forth serial ports.

**Serial Port 3/Port 4 Use IRQ:**

Select an IRQ for the third and forth serial ports.

**Intel Lan Boot ROM:**

This item allows you to decide whether to invoke the boot ROM of the onboard LAN chip.

The choice: Enabled, Disabled.

### 3.8 Power Management Setup

The Power Management Setup allows you to configure your system to most effectively save energy while operating in a manner consistent with your own style of computer use.

Phoenix - AwardBIOS CMOS Setup Utility  
Power Management Setup

Power Management	User Define	Item Help
Video Off Method	DPMS	
Video Off In Suspend	Yes	
Suspend Type	Stop Grant	Menu Level ➤
MODEM Use IRQ	3	
Suspend Mode	Disabled	
HDD Power Down	Disabled	
Soft-Off by PWR-BTTN	Instant-Off	
CPU THER-Throttling	50.0%	
Wake-Up by PCI card	Disabled	
Power On By Ring or WOL	Enabled	
Resume by Alarm	Disabled	
X Date (of Month) Alarm	0	
X Time (hh:mm:ss) Alarm	0 : 0 : 0	
** Reload Global Timer Events **		
Primary IDE 0	Disabled	
Primary IDE 1	Disabled	
Secondary IDE 0	Disabled	
Secondary IDE 1	Disabled	
FDD, COM, LPT Port	Disabled	
PCI PIRQ [A-D]#	Disabled	
↑↓←→Move Enter: Select +/-/PU/PD: Value F10: Save ESC: Exit F1: General Help F5: Previous Values F6: Fail-safe defaults F7: Optimized Defaults		

#### Power Management:

This category allows you to select the type (or degree) of power saving and is directly related to the following modes:

1. HDD Power Down
2. Doze Mode
3. Suspend Mode

**Min. Power Saving:**

Minimum power management. Doze Mode = 1 hr. Standby Mode = 1 hr., Suspend Mode = 1 hr., and HDD Power Down = 15 min.

**Max. Power Saving:**

Maximum power management -- **ONLY AVAILABLE FOR SL CPU's.** Doze Mode = 1 min., Standby Mode = 1 min., Suspend Mode = 1 min., and HDD Power Down = 1 min.

**User Defined:**

Allow you to set each mode individually. When not disabled, each of the ranges is from 1 min. to 1 hr. except for HDD Power Down, which ranges from 1 min. to 15 min. and disable.

**Video Off Method:**

This determines the manner in which the monitor is blanked.

**V/H SYNC+Blank:**

This selection will cause the system to turn off the vertical and horizontal synchronization ports and write blanks to the video buffer.

**Blank Screen:**

This option only writes blanks to the video buffer.

**DPMS:**

Initial display power management signaling.

**Video Off In Suspend:**

This determines the manner in which the monitor is blanked.

The choice: Yes, No.

**Suspend Type:**

Select the Suspend Type.

The choice: PWRON Suspend, Stop Grant.

**MODEM Use IRQ:**

This determines the IRQ in which the MODEM can use.

The choice: 3, 4, 5, 7, 9, 10, 11 and NA.

**Suspend Mode:**

When “Enabled” and after the set time of system inactivity. All devices except the CPU will be shut off.

The choice: Enabled, Disabled.

**HDD Power Down:**

When “Enabled” and after the set time of system inactivity, the hard disk drive will be powered down while all other devices remain active.

The choice: Enabled, Disabled.

**Soft-Off by PWR-BTTN:**

Pressing the power button for more than 4 seconds forces the system to enter the Soft-Off state when the system has “hung.”

The choice: Delay 4 Sec, Instant-Off.

**CPU THER-Throttling:**

Select the CPU THRM-Throttling rate.

The choice: 12.5%, 25.0%, 37.5%, 50.0%, 62.5%, 75.0% and 87.5%.

**Wake-Up by PCI Card:**

An input signal from PME on the PCI card awakens the system from a soft off state.

The choice: Enabled, Disabled.

**Power On by Ring or WOL:**

An input signal on the serial Ring Indicator (RI) line (in other words, an incoming call on the modem) awakens the system from a soft off state.

The choice: Enabled, Disabled.

**Resume by Alarm:**

When “Enabled”, you can set the date and time at which the RTC (real-time clock) alarm awakens the system from Suspend mode.

The choice: Enabled, Disabled.

**Reload Global Timer Events:**

The events are I/O events whose occurrence can prevent the system from entering a power saving mode or can awaken the system from such a mode. In effect, the system remains alert for anything, which occurs to a device, which is configured as Enabled, even when the system is in a power down mode.

Primary IDE 0

Primary IDE 1

Secondary IDE 0

Secondary IDE 1

FDD, COM, LPT Port

PCI PIRQ [A-D] #

### 3.9 PnP/PCI Configurations

This section describes configuring the PCI bus system. PCI, or **Personal Computer Interconnect**, is a system, which allows I/O devices to operate at speeds nearing the speed the CPU itself uses when communicating with its own special components. This section covers some very technical items and it is strongly recommended that only experienced users should make any changes to the default settings.

Phoenix - AwardBIOS CMOS Setup Utility  
PnP/PCI Configurations

Reset Configuration Data	Disabled	Item Help
Resources Controlled By	Auto (ESCD)	Menu Level >
X IRQ Resources	Press Enter	
PCI/VGA Palette Snoop	Disabled	
↑↓←→Move Enter: Select +/-/PU/PD: Value F10: Save ESC: Exit F1: General Help F5: Previous Values F6: Fail-safe defaults F7: Optimized Defaults		

#### Reset Configuration Data:

Normally, you leave this field Disabled. Select Enabled to reset Extended System Configuration Data (ESCD) when you exit Setup if you have installed a new add-on and the system reconfiguration has caused such a serious conflict that the operating system cannot boot.

The choice: Enabled, Disabled.

#### Resource controlled by:

The Award Plug and Play BIOS has the capacity to automatically configure all of the boot and Plug and Play compatible devices. However, this capability means absolutely nothing unless you are using a Plug and Play operating system such as Windows®95. If you set this field to "Manual" choose specific resources by going into each of the sub menu that follows this field (a sub menu is preceded by a ">").

The choice: Auto (ESCD), Manual.

#### IRQ Resources:

When resources are controlled manually, assign each system interrupt a type, depending on the type of device using the interrupt.

#### PCI/VGA Palette Snoop:

Leave this field at "Disabled".

The choice: Enabled, Disabled.

### 3.10 PC Health Status

Phoenix - AwardBIOS CMOS Setup Utility

PC Health Status

CPU Warning Temperature	Disabled	Item Help
Current CPU Temp.	40°C / 104°F	
Current System Temp.	24°C / 75°F	
Current Chassis Fan Speed	3283RPM	Menu Level >
Current CPU Fan Speed	5152RPM	
Current Power Fan Speed	4182RPM	
Current CPUFan4 Speed	0	
Vagp (V)	1.52V	
Vcore (V)	1.71V	
Vdimm (V)	2.48V	
+ 5 V	4.81V	
+12 V	11.73V	
Shutdown Temperature	Disabled	
↑↓←→Move Enter: Select +/-/PU/PD: Value F10: Save ESC: Exit F1: General Help F5: Previous Values F6: Fail-safe defaults F7: Optimized Defaults		

**CPU Warning Temperature:**

This item will prevent CPU from overheating.

The choice: 30-120, Disabled.

**Current CPU Temp:**

Show you the current CPU temperature.

**Current System Temp:**

Show you the current system temperature.

**Current Chassis Fan Speed:**

Show you the current CPU fan operating speed.

**Current CPU Fan Speed:**

Show you the current CPU fan operating speed.

**Current Power Fan Speed:**

Show you the current Power fan operating speed.

**Current CPUFan4 Speed:**

Show you the current Fan4 operating speed.



**Vagp (V)**

The voltage level of Power supplied to AGP card.

**Vcore (V)**

The voltage level of CPU (Vcore).

**Vdimm (V)**

The voltage level of the DRAM.

**+5V/+12V:**

Show you the voltage of +5V/+12V.

**Shutdown Temperature:**

This item allows you to set up the CPU shutdown Temperature. This item is only effective under Windows® 98 ACPI mode.

The choice: Disabled, 60°C / 140°F, 65°C / 149°F, 70°C / 159°F and 75°C / 167°F.

### 3.11 Frequency/Voltage Control

Phoenix - AwardBIOS CMOS Setup Utility

Frequency/Voltage Control

CPU Clock Ratio	22X	Item Help
Watch Dog Function	Enabled	
CPU FSB / SPEED	100MHz/2.40GHz	
Memory Frequency	Auto=>DDR266	Menu Level >
Next boot AGP/PCI is	66/33MHz	
AGP / PCI Clock	Auto	
AGP/PCI subtle tuning	66MHz	
Clock Generation for EMI	Press Enter	
↑↓←→Move Enter: Select +/-/PU/PD: Value F10: Save ESC: Exit F1: General Help F5: Previous Values F6: Fail-safe defaults F7: Optimized Defaults		

#### CPU Clock Ratio:

This item allows you to set up the CPU clock ratio, but this function depends on different CPU performance. It is only effective for those clock ratio haven't been locked.

#### Watching Dog Function

If you select enabled and overclock fail before POST code 26h, the system will reset automatically by default configuration.

The choice: Enabled, Disabled.

#### CPU FSB / SPEED:

This item allows you to enabled or disabled the CPU FSB speed.

The choice: 90MHz~ 200MHz.

#### Memory Frequency:

Enables you to select a ratio of the Double Data Rate Synchronous DRAM to match the installed DRAM frequency 200/266/333MHz.

#### AGP/PCI Clock:

Enables you to select host clock to work concurrently with the PCI bus or the AGP bus.

#### AGP/PCI subtle tuning:

Enables you to select AGP/PCI frequency.

**Clock Generation for EMI:**

Clock Generation for EMI	
Auto Detect PCI Clk      Enabled	Item Help
Spread Spectrum Modulated    Disabled	_____
	Menu Level    ➤
↑↓←→Move    Enter: Select    +/-/PU/PD: Value    F10: Save    ESC: Exit    F1: General Help F5: Previous Values    F6: Fail-safe defaults    F7: Optimized Defaults	

**Auto Detect PCI Clk:**

When enabled the mainboard automatically disables the clock source for a PCI slot which does not have a module in it, reducing EMI (ElectroMagnetic Interference).

**Spread Spectrum Modulated:**

If you enable spread spectrum, it can significantly reduce the EMI (ElectroMagnetic Interference) generated by the system.

### 3.12 Load Fail-Safe Defaults

When you press <Enter> on this item you get a confirmation dialog box with a message similar to:

Load Fail-Safe Defaults (Y/N)? **N**

Pressing 'Y' loads the BIOS default values for the most stable, minimal-performance system operations.

### 3.13 Load Optimized Defaults

When you press <Enter> on this item you get a confirmation dialog box with a message similar to:

Load Optimized Defaults (Y/N)? **N**

Pressing 'Y' loads the default values that are factory settings for optimal performance system operations.

### 3.14 Supervisor/User Password Setting

You can set either supervisor or user password, or both of them. The differences between are:

**Set Supervisor Password:** can enter and change the options of the setup menus.

**Set User Password:** just can only enter but do not have the right to change the options of the setup menus. When you select this function, the following message will appear at the center of the screen to assist you in creating a password.

#### ENTER PASSWORD:

Type the password, up to eight characters in length, and press <Enter>. The password typed now will clear any previously entered password from CMOS memory. You will be asked to confirm the password. Type the password again and press <Enter>. You may also press <Esc> to abort the selection and not enter a password.

To disable a password, just press <Enter> when you are prompted to enter the password. A message will confirm the password will be disabled. Once the password is disabled, the system will boot and you can enter Setup freely.

#### PASSWORD DISABLED.

When a password has been enabled, you will be prompted to enter it every time you try to enter Setup. This prevents an unauthorized person from changing any part of your system configuration.

Additionally, when a password is enabled, you can also require the BIOS to request a password every time your system is rebooted. This would prevent unauthorized use of your computer.

You determine when the password is required within the BIOS Features Setup Menu and its Security option (see Section 3). If the Security option is set to "System", the password will be required both at boot and at entry to Setup. If set to "Setup", prompting only occurs when trying to enter Setup.

### 3.15 Exit Selecting

#### Save & Exit Setup

Pressing <Enter> on this item asks for confirmation:

**Save to CMOS and EXIT (Y/N)?**  Y

Pressing “Y” stores the selections made in the menus in CMOS – a special section of memory that stays on after you turn your system off. The next time you boot your computer, the BIOS configures your system according to the Setup selections stored in CMOS. After saving the values the system is restarted again.

#### Exit Without Saving

Pressing <Enter> on this item asks for confirmation:

**Quit without saving (Y/N)?**  Y

This allows you to exit Setup without storing in CMOS any change. The previous selections remain in effect. This exits the Setup utility and restarts your computer.