

# ***Hypertherm***<sup>®</sup>

## **Attention!**

The shock absorbing washers provided in this kit should be installed on the flowtubes in any HD3070 manual gas console which does not have them. They have proved to be very effective in reducing flow tube breakage, especially breakage at the top of the flowtubes.

In cases where breakage at the bottom of the flowtubes persists, even with shock absorbing washers installed, please contact your supplier and request Kit 128552. This kit provides check valves for installation on gas inlets.



# Manual Gas Console Flowmeter Upgrade

Kit: 128461

## Kit Instructions

(P/N 803630)

Revision 4 - August 2000

Hypertherm, Inc.  
Hanover, NH USA  
<http://www.hypertherm.com>  
email: [info@hypertherm.com](mailto:info@hypertherm.com)

© Copyright 1999 Hypertherm, Inc.  
All Rights Reserved

Hypertherm and HyDefinition are trademarks of Hypertherm, Inc. and may be registered in the United States and/or other countries.

## **Hypertherm Offices Worldwide:**

### **Hypertherm, Inc.**

Etna Road, P.O. Box 5010  
Hanover, NH 03755 USA  
Tel.: (603) 643-3441 (Main Office)  
Fax: (603) 643-5352 (All Departments)  
Tel.: (800) 643-9878 (Technical Service – toll-free in USA and Canada)  
Tel.: (800) 737-2978 (Customer Service – toll-free in USA and Canada)  
email: info@hypertherm.com (General Information)  
email: service@hypertherm.com (Technical/Customer Services)

### **Hypertherm Plasmatechnik GmbH**

Technologiepark Hanau  
Rodenbacher Chaussee 6  
D-63457 Hanau-Wolfgang, Germany  
Tel.: 49 6181 58 2100  
Fax: 49 6181 58 2134

### **Hypertherm (S) Pte Ltd**

No. 19 Kaki Bukit Road 2  
K.B. Warehouse Complex  
Singapore 417847  
Tel.: 65 841 2489  
Fax: 65 841 2490

### **Hypertherm UK Ltd**

9 Berkeley Court, Manor Park  
Runcorn, Cheshire, England WA7 1TQ  
Tel.: 44 1928 579 074  
Fax: 44 1928 579 604

### **France**

15 Impasse des Rosiers  
95610 Eragny, France  
Tel.: 33 1 30 37 15 28  
Fax: 33 1 30 37 15 79

### **Hypertherm S.r.L.**

Via Torino 2  
20123 Milan, Italy  
Tel.: 39 02 725 46 312 (Customer Service)  
Tel.: 39 02 725 46 314 (Technical Service)  
Fax: 39 02 725 46 400 (All Departments)

### **Hypertherm B.V.**

Burg, Haverkampstraat 13  
7091 CN Dinxperlo, The Netherlands  
Tel.: 31 315 655 866 (Customer Service)  
Fax: 31 315 655 886

### **European Technical Support Organization (ETSO)**

Edisonstraat 12  
3281 NC Numansdorp, The Netherlands  
Tel.: 00 800 4973 7843 (00 800 Hypertherm) – (toll-free Technical Service)  
Tel.: 31 186 659494  
Fax: 31 186 659495

### **Japan**



Shinjuku Park Tower  
30th Floor  
3-7-1 Nishi-Shinjuku  
Shinjuku-ku, Tokyo  
163-1030, Japan  
Tel.: 81 03 5326 3142  
Fax: 81 03 5326 3001



# HyDefinition Flow Meter Upgrade

---

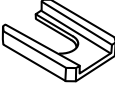
## 128461 KIT CONTENTS

	<u>Part Number</u>	<u>Description</u>	<u>Qty</u>
	004872	Spacer	4
	027653	Shock Absorbing Washer	4
	027652	Teflon Washer	8
	803630	Kit Instructions	1

## PURPOSE

The high velocity gas flow of the HyDefinition system can result in broken flow meter tubes. To improve the reliability of the flow meters, the above kit should be installed in the HyDefinition manual gas console.

# HyDefinition Flow Meter Upgrade

## INSTRUCTIONS

	<p><b>WARNING</b> HIGH PRESSURE GAS CAN CAUSE INJURY</p>
<p>Glass tubes will break if gas pressure is not properly removed. Disconnect all gas lines from gas console before performing any maintenance.</p> <p>All work must be performed by a Hypertherm Distributor or a qualified technician.</p>	

### Remove Gas Pressure - Critical Process

1. Turn on power to power supply.

2. Turn off incoming gases.

**3** Remove supply gas lines to gas console.

NOTE The power supply pressure switches will open when system pressure drops to below interlock pressure.

**4** Remove plasma, shield, and preflow lines from gas console.

**5** Cycle Process Selection switch through all positions.

**6** Check that all the pressure gauges (for both supply and output gases) read zero (0) pressure. Repeat steps 1 through 5 if required.

7. Turn off electrical power to power supply.

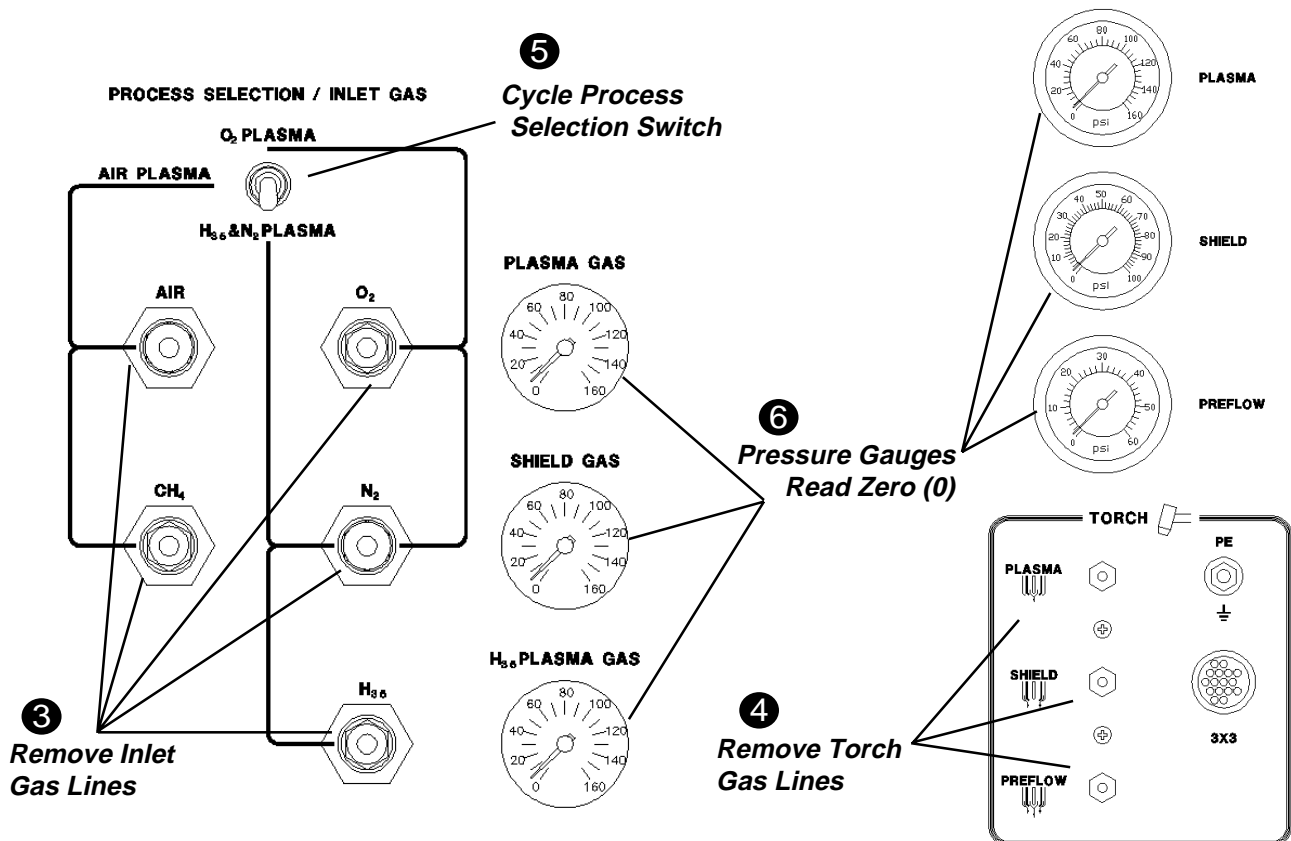

# HyDefinition Flow Meter Upgrade

## Remove Glass Tube

1. Remove plastic cover.
2. Remove and discard clip.
3. Push plunger up into housing.
4. Remove glass tube.

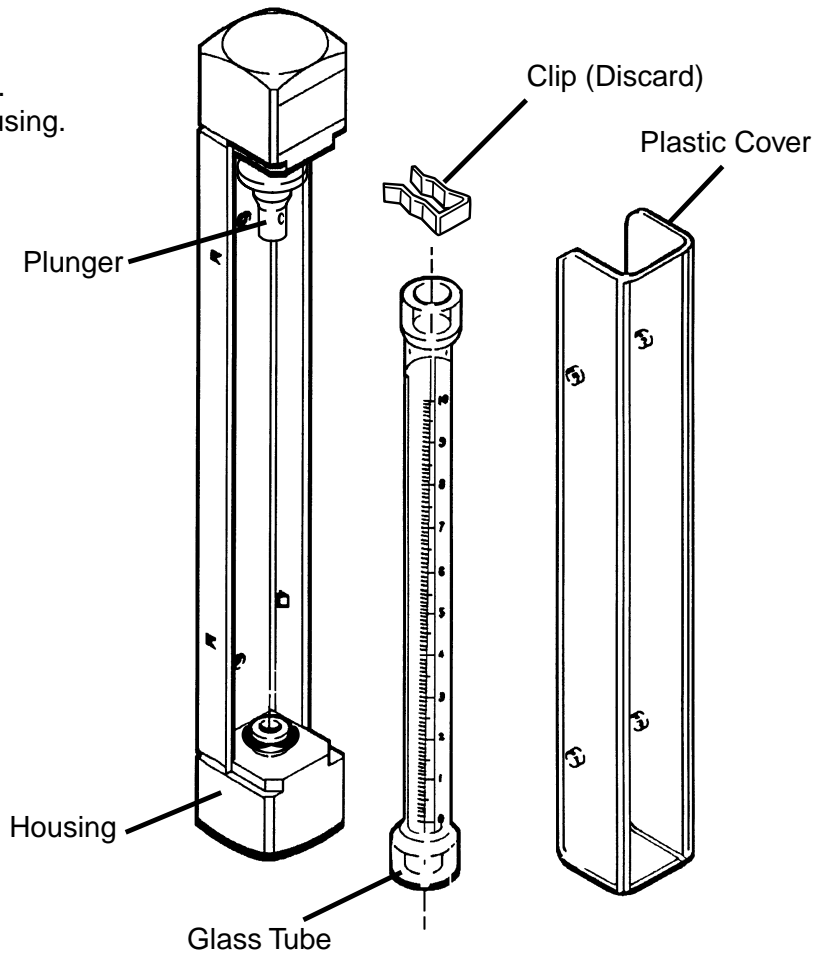

# HyDefinition Flow Meter Upgrade

## Install kit parts and glass tube

1. Install Teflon washer over housing o-ring.
2. Install Teflon washer over plunger o-ring.

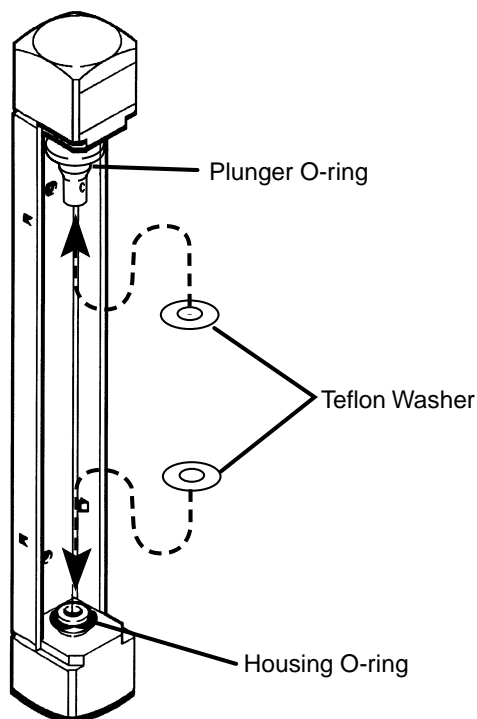

3. Install glass tube.
4. Push plunger down into the glass tube as far as it will go.

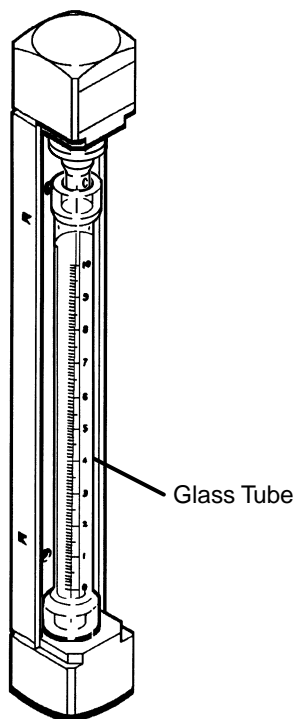

5. Install shock absorbing gasket onto plunger.
6. Install spacer onto plunger.
7. Install plastic cover.

